

DATE: _____
 PROJECT: _____
 LOCATION: _____



**Downblast Centrifugal
 Exhaust Ventilator
 Hurricane / Missile Impact Resistant
 Roof Mounted/Direct Drive**



DIMENSION DATA

Size	A	B	C	G	T Sq.	Ship Wt.	Roof Opening Sq.*
70	1-3/4	13-5/8	13-13/16	2	18	20	13-1/2
90	2-1/2	18-3/4	16-13/16	2	18	28	13-1/2
100	2-1/2	18-3/4	16-13/16	2	18	30	13-1/2
120	1-7/16	28-7/16	26-9/16	2	20	67	15-1/2
135	1-15/16	28-7/16	27-1/16	2	20	72	15-1/2
150	2-13/16	32-7/8	28-11/16	2	24	87	19-1/2
165	3-5/16	32-7/8	29-3/16	2	24	90	19-1/2
180	3-5/16	37-11/16	33-15/16	3	30	102	25-1/2

ALL DIMENSIONS IN INCHES. WEIGHTS IN LBS.
 * ROOF OPENING SIZE FOR CURBS SUPPLIED BY COOK ONLY.

MIAMI-DADE COUNTY, FLORIDA

Notice of Acceptance (NOA) Number 18-0614.04/10-2-2023

- TAS-201: Large Missile Impact Test
- TAS-202: Uniform Static Air Pressure Test
- TAS-203: Cyclic Wind Pressure Test

STANDARD CONSTRUCTION FEATURES:

All aluminum housing - Backward inclined all aluminum wheel -
 Removable top cap - Welded curb cap corners - Birdscreen -
 Permanently lubricated ball bearing motors - Corrosion resistant
 fasteners - Transit tested packaging.

ACCESSORIES

1. DISCONNECT SWITCH
2. GRAVITY BACKDRAFT DAMPER
3. MOTORIZED BACKDRAFT DAMPER
4. RCG GALVANIZED CURB
5. RCA ALUMINUM CURB
6. FAN SPEED CONTROL
7. EPOXY COATING
8. EPOXY PHENOLIC COATING
9. LORENIZED COATING
10. ANTI-CONDENSATE COATING
11. LESS BIRDSCREEN
12. SPECIAL

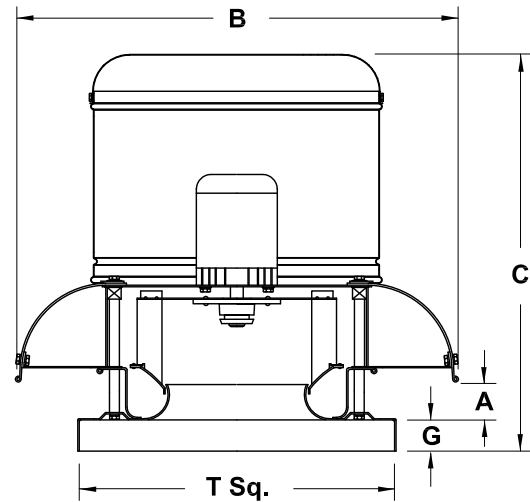

QTY	MARK	CATALOG NUMBER	FAN INFORMATION			MOTOR INFORMATION					ACCESSORIES	
			CFM	SP	RPM	HP	VOLTS	HZ	PH	TYPE		

MOTOR TYPE: ODP (OPEN DRIP-PROOF); 2 SP (2 SPEED); X-PRF (EXPLOSION PROOF);
 TEFC (TOTALLY ENCLOSED FAN COOLED).